

Bright

Instruments

9400 CRYOSTAT



Contents

1. INTRODUCTION	8	3.2.2 Auto cycle	13	3.12.1 Types of knife	25
1.1 Receipt of product	8	3.2.3 Manual mode	13	3.13 Fitting a Specimen Plate	26
1.1.1 Site requirements	8	3.3 Main Screen (F1)	14	3.13.1 Specimen plate options	26
1.1.2 Unloading	8	3.4 Manual (F2)	15	3.14 Anti roll assembly	27
1.1.3 Receipt	9	3.5 Light (F3)	17	4. CARE AND MAINTENANCE	28
1.1.4 Unpacking	9	3.6 Set-up (F4)	17	4.1 Daily care	28
1.1.5 Settling	9	3.7 Help (F5)	18	4.2 Cleaning under the debris blinds	28
1.2 Setting up	9	3.8 Count (F6)	19	4.3 Solid Microtome Knives	28
1.2.1 Microtome Installation and Removal	9	3.9 Fault reset (F7)	20	4.4 Defrosting	29
1.2.2 Connections	9	3.10 Menu (F8)	20	4.4.1 Automatic Defrost cycle	29
1.3 Safety	9	3.10.1 Menu - (F8) User administration	21	4.4.2 Full defrost	29
2. QUICK START	10	3.10.2 Menu (F8) - Time & Date	22	4.5 Decontamination	29
3. OPERATING INSTRUCTIONS	12	3.10.3 Menu (F8) - Defrost	23	4.6 Operating in hot climates	29
3.1 HMI Overview	12	3.11 Access into to the chamber	24	4.7 Servicing and repairs	30
3.2 Knee Control lever	13	3.11.1 Large Access lid	24	4.7.1 UK	30
3.2.1 How to use general	13	3.11.2 Small Access lid	24	4.7.2 Rest of the world	30
		3.12 Fitting a knife	25		

Contents Cont.

ACCESSORIES	31
Spares & Accessories	32
REFERENCES & DRAWINGS	33
Figure 1. 9400 Cabinet	34
Figure 2. 9400 Microtome	35
Figure 3. Anti-Roll Set-up	36



SAFETY WARNING

Low temperatures are present in this equipment. Extreme care should be taken.

DO NOT let bare skin come into contact with metal surfaces.



SAFETY WARNING

Extremely sharp knives/blades.
Use correct tools for removal and insertion of knives/blades.

DO NOT leave knives/blades laying around.
Place knives/blades not in use, into box/wallet provided.



SAFETY WARNING

Operators should wear suitable clothing such as close-fitting clothing and use personal protective equipment such as safety gloves and glasses at all times.

The protective devices on the instrument must not be removed or modified in any way.

Only connect the instrument to a grounded power socket.

The lid is extremely heavy, due care and attention should be given when opening and closing, ensuring the window is closed or open completely.

Safety Information

CONSUMER PROTECTION

The Consumer Protection Act 1987 Part 1, refers to Product Liability. This legislation was issued as a direct result of an EC Directive to all member states and has been in force with effect from 01 March 1988.

Bright Instrument Company Limited, ever mindful of the need to ensure that their products are not subject to misuse and/or incorrect handling, have made it their aim to communicate any possible dangers to their customers.

Whilst Bright Instrument Company Limited markets products manufactured to the highest safety standards, it is in the interest of the purchaser that he is aware of the resultant dangers of misuse and/or incorrect handling of these products.

Your attention is therefore drawn to the following precautions:

Electrical

Warnings - A warning notice is fixed to the instrument stating that it should be disconnected from the power supply before removing the panels. This warning should be strictly observed. This cryostat is fitted with an in line mains filter which may affect portable appliance test results.

Fuses - Fuse ratings are clearly indicated on all fuse panels adjacent to the fuse holder. If and when replacement is necessary, the correct fuse rating must be adhered to.

Earthing (Grounding) - A protective earth terminal is fitted, and must be used in all two wire installations.

Microtome Knives & Blades

Microtome knives can be hazardous in the laboratory. Personnel should be made aware of the dangers and observe the following warnings:

Do not leave the microtome unattended with an exposed knife in position. Remove the knife, or cover it with the guards provided.

Do not leave knives lying around. Place knives that are not in use in their boxes.

Do not carry knives unless secure in the box provided.

d. Do not clean the knife along its length. Wipe from the back edge of the cutting edge.

Remember that even used knives are dangerous – they are still sharp and may have been used to cut potentially infectious specimens.

Dispose of used knives with the same care as other sharp objects. On no account should used knives be placed in waste bins.

1. Introduction

Bright instruments have been specialising in the development and production of cryostats for over 50 years.

The Bright Instruments 9400 cryostat has been developed for applications when normal cryostats are not large or powerful enough.

The Control panel is the central point of control for the unit, allowing the user to easily customise settings such as temperature, thickness, batch quantities and switch between single and continuous cutting modes.

The 9400 is an extremely versatile machine and can be used in sectors such as:

- Medical
- Histology
- Research
- Life Science
- Automotive
- Forestry
- Material Analysis

1.1 RECEIPT OF PRODUCT

This instrument received a final test and inspection prior to dispatch from the factory. The following instructions are given for the re-assembly of the instrument, adjustments and its correct use. If the instrument is received before preparations for installation are completed. It should be stored in a clean, dry place and not exposed to dirty or damp conditions.

1.1.1 SITE REQUIREMENTS

- Relative humidity of 60% and non-condensing.
- Recommended to be installed in an air conditioned room with the temperature set between +5°C & +22°C. (Un-maintained room temperatures may impact negatively on performance.
- The floor surface should have sufficient load capacity and rigidity for the weight of the instrument.
- Cryochamber unit - gross weight 395kgs
- Refrigeration unit - gross weight 144kgs
- The unit should be positioned on a level floor.

- The Cryochamber should not be sited under an air conditioning unit.
- The instrument is designed for indoor use only.
- The instrument must be connected to a grounded socket, only use the cable provided. Never use an extension lead.
- The power supply plug must be easily accessible.
- Avoid vibrations and direct exposure to sunlight and heavy temperature fluctuations.

1.1.2 UNLOADING

During unloading operations and handling, avoid tilting the unit and any abrupt manoeuvres.

When unloading, to avoid injury to the head and limbs (hands, feet) operators must wear the following protective clothing with the CE mark: helmet, leather gloves and shoes with a reinforced tip.



Safety
Helmet must
be worn



Protective
Gloves must
be worn



Protective
Footwear must
be worn

1.1.3 RECEIPT

Immediately upon receipt of the instrument, make a careful examination for evidence of damage encountered in transit. If any damage is found or suspected, notify both the carrier and Bright Instrument Company Limited immediately.

1.1.4 UNPACKING

All packing must be carefully removed and parts checked against the enclosed packing list. If any damage or discrepancy is noted, please inform our agent/distributor or Bright Instrument Company Limited immediately.

1.1.5 SETTling

During transit the oil in the compressor will have been subject to movement, so it is important to let the cryostat settle before switching on. We recommend the instrument is left standing for at least eight hours (preferably overnight) before switching on.

Moving the instrument around on its castors, e.g. from one laboratory to another, will not affect the compressor oil.

1.2 SETTING UP

The machine is made up of two units the Cryochamber unit and the Refrigeration unit. Once transported to the installation location both units are then connected via four toggle latches.

Leave a gap of at least 100mm on either side of the unit, this is necessary to ensure adequate ventilation. Ensure that the instrument has been positioned away from direct, hot sunlight and is in a location completely free from draughts.

The Cryochamber unit is mounted on six castors (three lockable) and the Refrigeration unit on four (two lockable). All wheels are accompanied by an adjustable foot to compensate for any uneven flooring where the unit is set up.

1.2.1 MICROTOME INSTALLATION AND REMOVAL

The installation and removal of the Microtome should only be carried out by a qualified Bright engineer. The Microtome is positioned in the Cryochamber during shipment. Before operation, please remove all packaging.

1.2.2 CONNECTIONS

The Cryochamber unit requires connection to:

Single phase 220/240v

50hz

Connections:

Brown positive (live)

Blue negative (neutral)

Green / yellow (ground/earth)

20amp fuse

1.3 SAFETY

The instructions for use include important information relating to the safe operating practices of the instrument. It is recommended that routine maintenance is carried out and instructions are followed carefully prior to each start up.

The safety measures installed to this instrument constitute the basis for accident prevention. Operating the instrument safely is the responsibility of the user and company.

2. Quick Start

- Ensure the unit is plugged into an appropriate power source.
- Turn the Isolator switch on (See Figure 1).
- Fit knife into the knife clamps set the angle and lock the knife in place refer to 3.12.
- If there are any errors press Fault reset (F7).
- Using the touchscreen, datum the X axis.
- Axis not datummmed should appear on main screen.

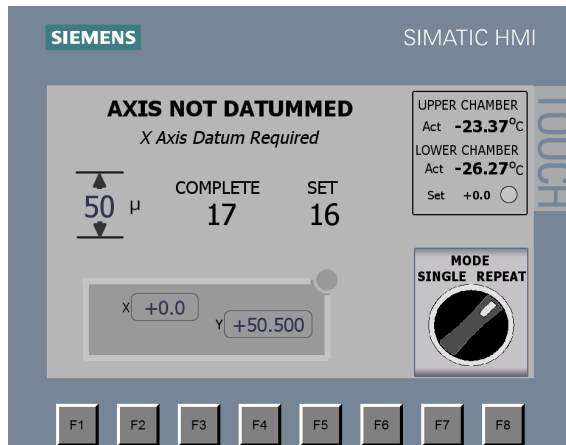

- Press Manual (F2) for manual control screen.

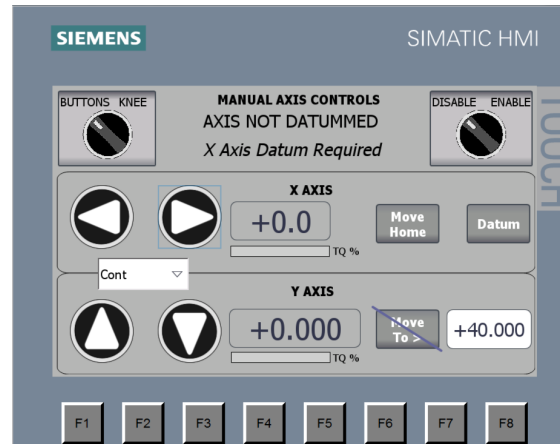

- Enable manual mode.

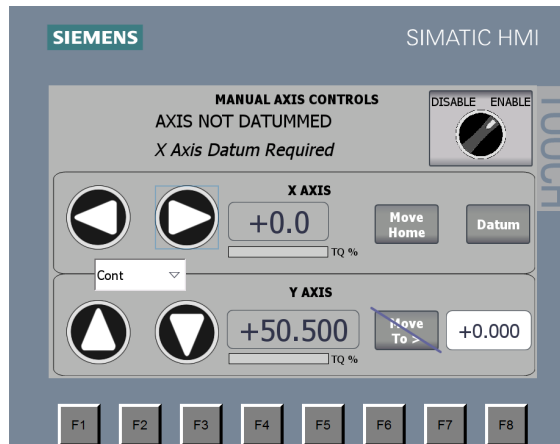

- On the touchscreen press and hold the Datum button until Datum complete message shows (If Motor's inhibited light is illuminated press the white Start button to activate them to allow Datum function).



The X axis value should read +0.0 when at datum point.

j. Move the table to its highest position (Y Axis), wait until the Motors Inhibited light is illuminated then mount the specimen onto the plate and allow time for it to freeze completely (An externally prepared sample on a plate can also be fitted).

k. Adjust the Y axis position so the highest point of the frozen specimen is just below the blade edge. If the specimen is left too far above this point damage could potentially occur to the knife/specimen. (If the stage won't move, ensure the "Motor's Inhibited" light is off).

l. Disable manual mode then go back to the main screen (F1), if Manual mode hasn't been disabled the main screen will display a "Disable Manual" button as shown below.

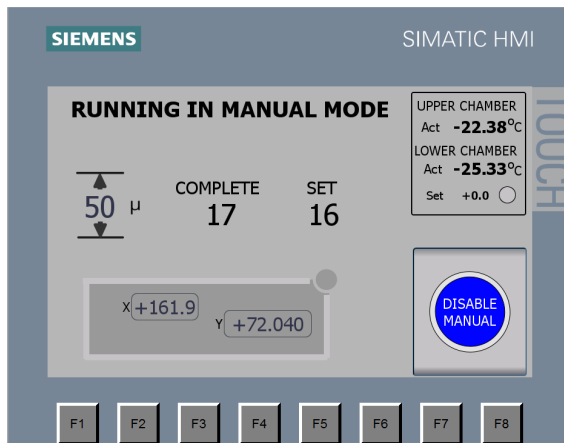

m. Go onto the set-up screen (F4) to set parameters for the initial trimming cycle. (Click on the values to edit).

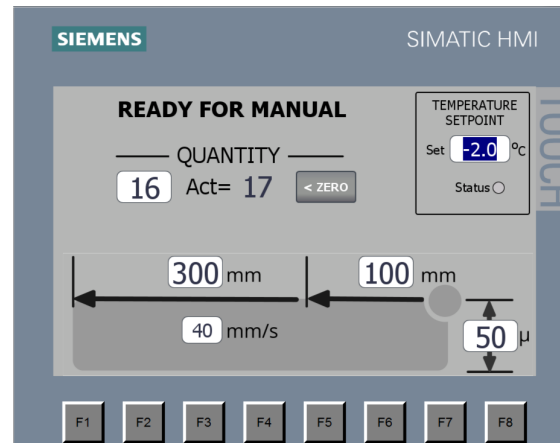

n. Once the parameters are set, return to the main screen (F1) and run the cycle, this can be done in either single cut or continuous cut mode.

o. Once trimming is complete repeat steps 9 & 10 but with the values for the sectioning sequence.

3. Operating instructions

3.1 HMI OVERVIEW



START

CYCLE STOP

Stops the microtome after its next complete cut

MOTOR'S INHIBITED INDICATOR LIGHT

When this light is on all microtome motors are disabled so it is safe to put hands in chamber

EMERGENCY STOP

Immediately stops the microtome

3.2 KNEE CONTROL LEVER

The Knee Control lever mounted on the front of the machine allows the user to traverse the axis backward and forward at a rate proportional to the displacement of the lever; this allows dynamic velocity adjustment during the cutting phase to achieve optimum performance.

The Knee Control lever can be used in both Manual and automatic modes. Both the Main screen (F1) and the Manual screen have a toggle switch to enable it.

3.2.1 HOW TO USE GENERAL

The Knee control lever has a paddle that can be flipped vertically to keep out of the way when not in use.

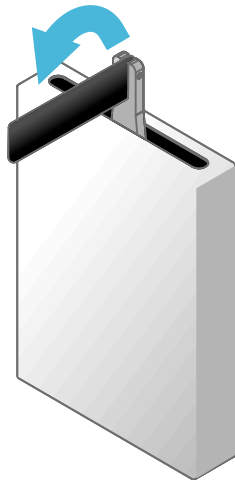

The travel speed is proportional the displacement of the Knee Lever and to the rapid/cutting velocities specified in the Setup Screen (F4). Setting the velocities to 80mm/s will give the operator full speed control via the lever.



3.2.2 AUTO CYCLE

To engage, the Knee control toggle switch must be set to on the Main Screen (F1). (Note that the switch can only be toggled when the machine is not running auto-cycle).

When the Knee Control Selector Switch is on, the Auto-cycle can only be started when the X axis is at the zero position however; if the auto-cycle is stopped (paused), then the cycle can be continued from any X axis position.

During the X axis cut phase of the cycle, the speed and direction of the X axis table will be dictated by the displacement of the Knee Control Lever. The operator is free to control the axis back/forward as required. If the X axis is traversed to the end of cutting window set on the setup screen (F4) then the regular auto-cycle is resumed for the return stroke back to the zero position (X) and adjusts the height (Y) ready for the next cut. If repeat cycle is selected, then the operator will again have control of the axis via the Knee Lever for the next cut.

3.2.3 MANUAL MODE

The buttons on the HMI are the default control for manually moving the axis. If Knee control is enabled from either the Main or Manual screens, then the X axis jog buttons are removed from the screen and the X axis is controlled via the Knee lever; the Y axis continues to use the buttons on the HMI.

Note: If the machine is running in auto-cycle with Knee Control enabled, and the operator does not operate the lever for >60s, then the auto-cycle will pause. The auto cycle can be re-started by pressing the Start button.

3.3 MAIN SCREEN (F1)

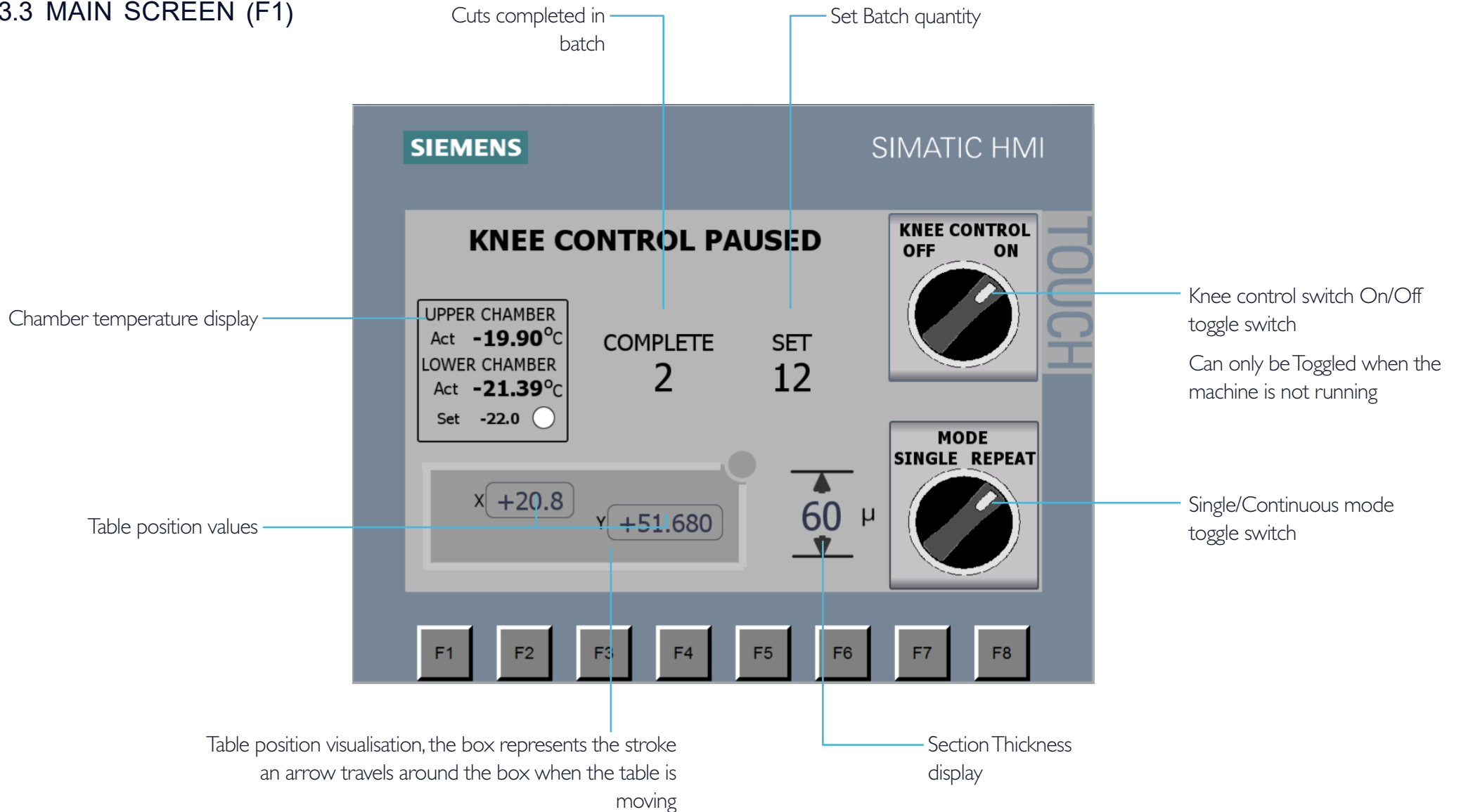

3.4 MANUAL (F2)

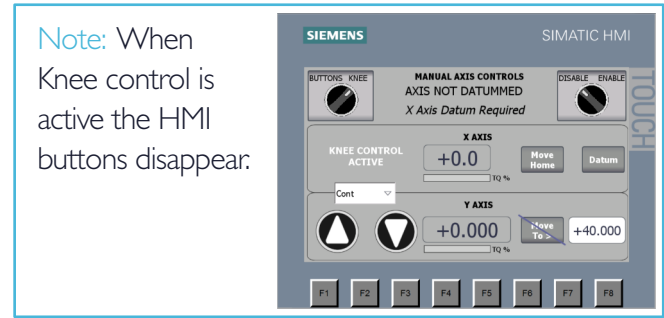

X axis Position

Y axis Position

X axis directional control method, user can use the buttons below on the HMI or select Knee control. (See Note)

Directional movement along X axis

Directional movement along Y axis

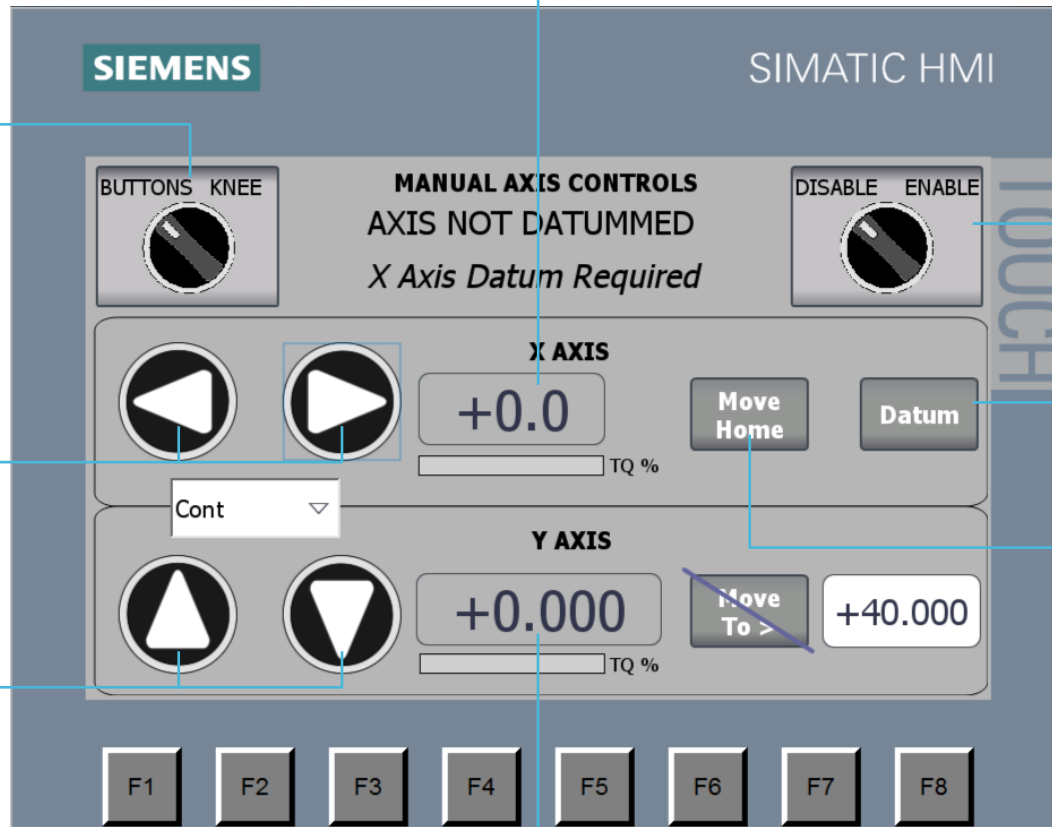

Disable/Enable Manual mode

Datums the X axis (Only required on start up)

Moves X axis to "Home Position" (+0.0)

MANUAL (F2) CONT.

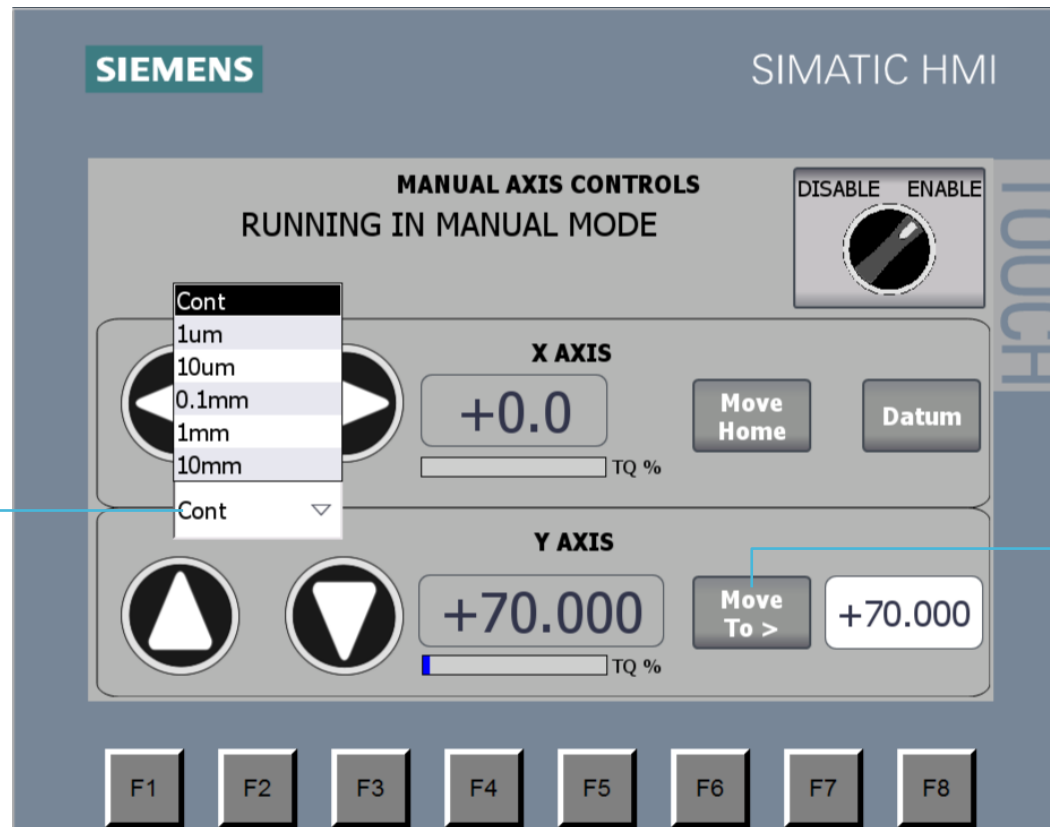

These values allow the user to select the travel distance for each press of any of the directional buttons, "Cont" stands for Continuous mode where movement occurs for as long as the button is pressed

Click here to set position for Y position
(+0.0 is at lowest position)

3.5 LIGHT (F3)

Press to turn chamber lights on/off.

3.6 SET-UP (F4)

The Zonal control allows you to set up different stroke speeds to speed up sectioning. The Stroke length up to cutting window is the distance between the home position to where the specimen reaches the blade edge, the specimen will travel the cutting window length at the set speed.

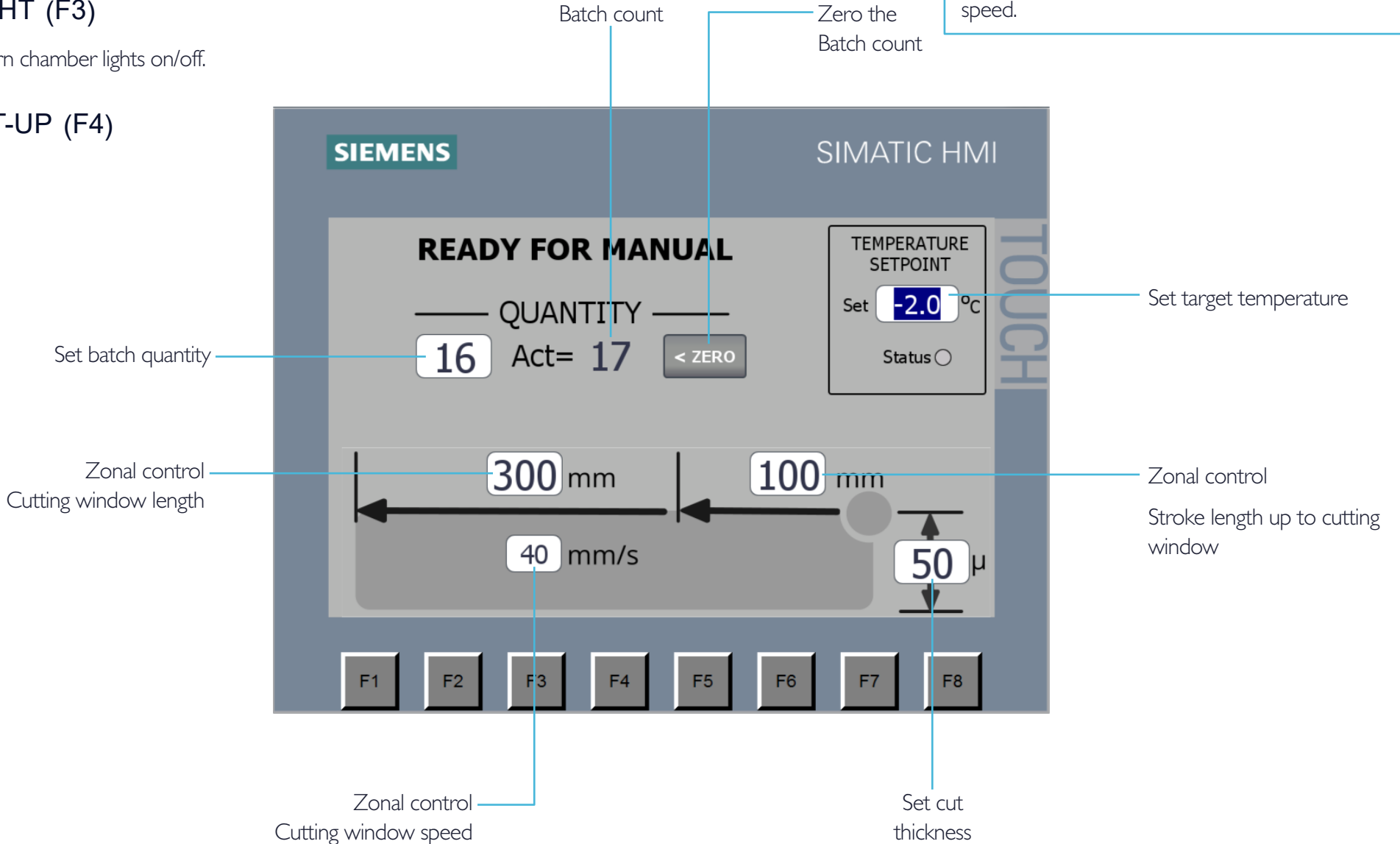

3.7 HELP (F5)

Here any faults/status updates are displayed. To reset any faults press Fault reset (F7).

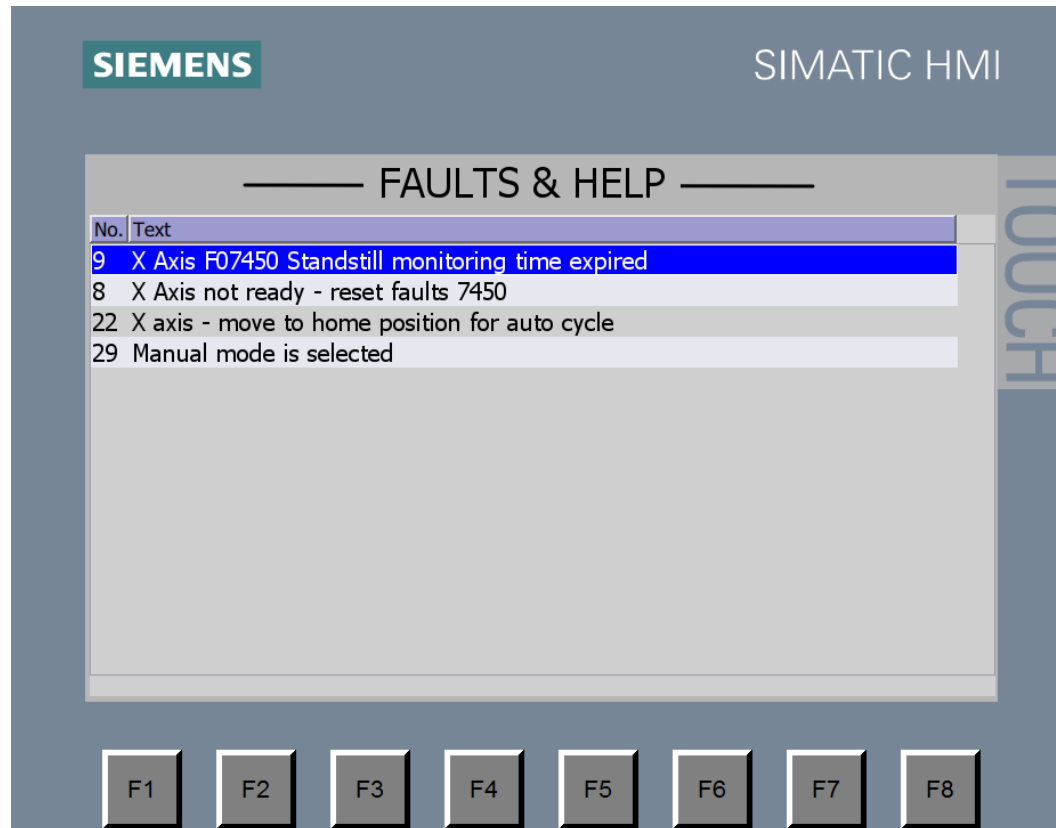

3.8 COUNT (F6)

The image shows a Siemens SIMATIC HMI screen displaying production data. The screen has a dark blue header with the 'SIEMENS' logo on the left and 'SIMATIC HMI' on the right. The main content area is titled 'PRODUCTION DATA' and lists three categories: 'THIS BATCH' with a value of 4, 'PREVIOUS BATCH' with a value of 20, and 'TOTAL' with a value of 154. A button labeled '< ZERO' is positioned next to the 'THIS BATCH' value. A vertical 'TOUCH!' label is on the right side of the screen. At the bottom, there is a row of eight function keys labeled F1 through F8. Blue lines with labels point to the '4', '< ZERO' button, '20', and '154' values.

Category	Value
THIS BATCH	4
PREVIOUS BATCH	20
TOTAL	154

Callouts:

- Batch count
- Zero the Batch count
- Previous Batch count
- Total cut count

3.9 FAULT RESET (F7)

Press to reset any faults.

3.10 MENU (F8)

Is for the Top level user/ service engineer to access the diagnostics and master settings.
(Some data can only be changed by users with a certain level of password access).

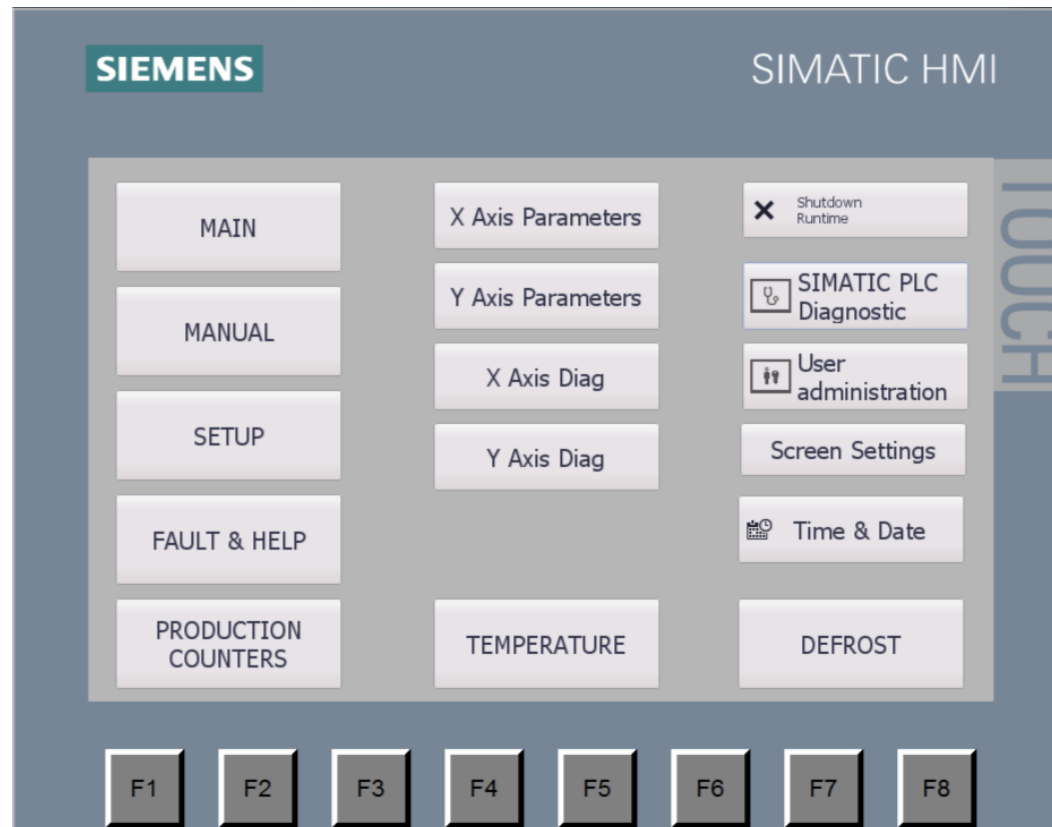

3.10.1 MENU - (F8) USER ADMINISTRATION

Note: If there is currently no user logged-on, then the detail list will be empty, pressing anywhere in the blank list will result in the password entry dialog appearing, you must initially enter a password to be able to view any other entries.

Return to Menu screen

Username Password Authorisation level Log current user off

SIEMENS SIMATIC HMI

Back **USER ADMINISTRATION** LOG OFF

User	Password	Group	Logoff time
Bright	*****	Bright	20
Op	*****	Users	0
Supervisor	*****	Manager	20
PLC User	*****	Unauthorized	5

TOUCH

F1 F2 F3 F4 F5 F6 F7 F8

The password system has three levels of authorisation. They are as follows:

Bright

- Adjust calibration settings
- Create/delete user accounts

Manager

- Change date and time
- Change defrost time and duration
- Set maximum cut thickness & retraction distance
- Screen brightness & saver time

User

- Routine operation

Here the Bright engineer is logged in and they can view other lower ranked user with status 'User' and 'Manager'.

Create a new user

- Click on the white space below the last user to make a new entry.
- Click on the password field to set its password.
- then associate it with a group (User, Manager or Bright engineer) to determine the authorisation level.
- Finally set a logoff time in minutes (10 or 20 minutes is recommended).

Note: The logged in user will only be able to see and all lower ranked users on this screen themselves.

Click on a user to change there password or click on the white space below the last user to make a new entry.

The time for the machine to log out when left unused.

Note: User will be asked for a Manager level password when accepting changes to the system clock.

3.10.2 MENU (F8) - TIME & DATE

Should the machine be powered off for a prolonged period of time, then it may be necessary to adjust the system clock.

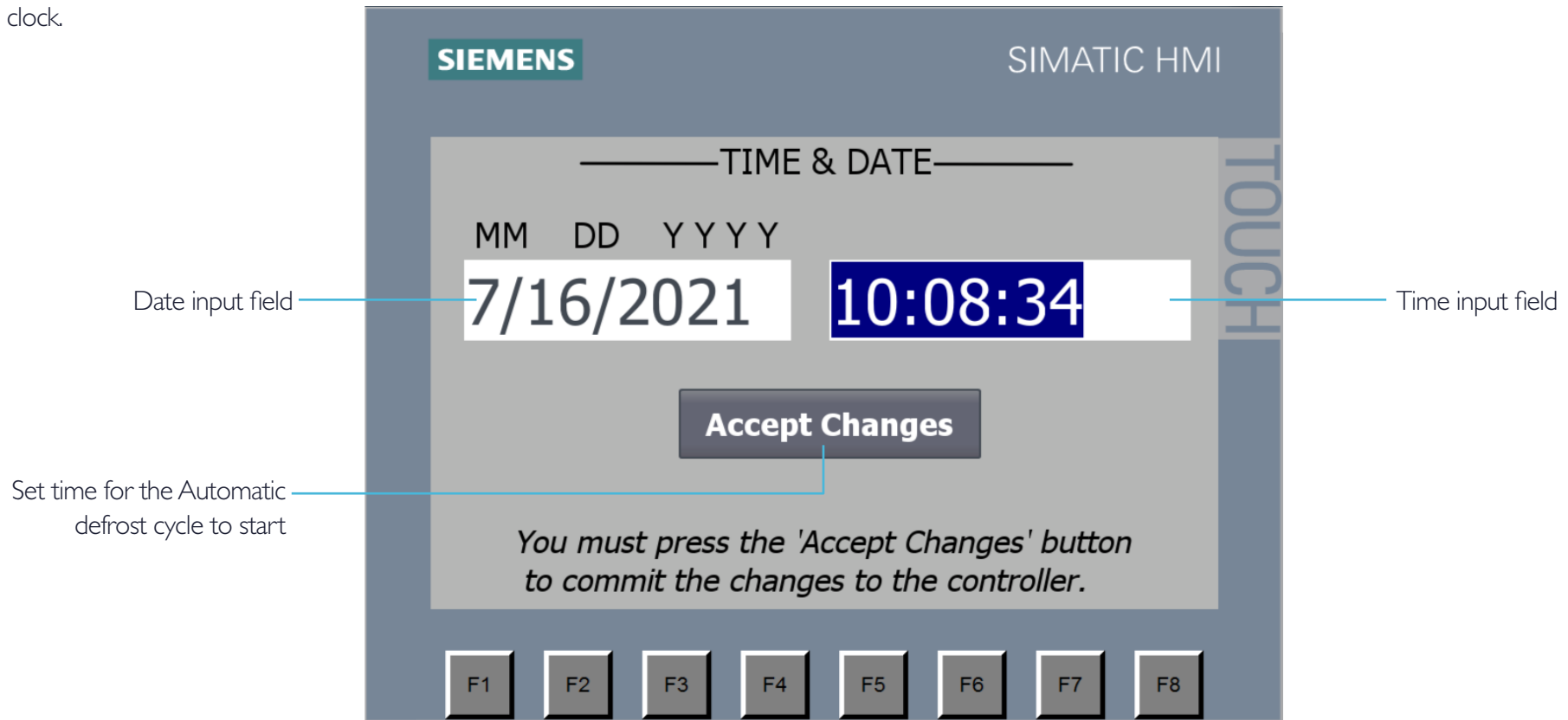

Note: A running defrost cycle can be aborted by switching the defrost mode switch to the off position.

3.10.3 MENU (F8) - DEFROST

The image shows a SIMATIC HMI screen for the DEFROST CONTROL menu. At the top, it displays 'SIEMENS' and 'SIMATIC HMI'. The main section is titled 'DEFROST CONTROL' and contains several interactive elements:

- HEATER TEST** and **FAN TEST** buttons: These are used to test the evaporator heaters and circulating fan. A callout states: "Evaporator heaters and circulating fan test buttons these devices will operate whilst the respective button is depressed."
- DEFROST NOW** button: Labeled "Start defrost cycle".
- DEFROST ENABLE** toggle switch: Has positions for 'OFF' and 'AUTO'. Labeled "Knee control switch On/Off toggle switch".
- Time** and **Temperature** displays: Shows "Time= 17:32:07" and "Temperature= +0.00°C".
- Defrost Start Time** and **Defrost Duration** displays: Shows "18:59" and "2 Mins". A callout for the duration display says: "Set duration for the Automatic defrost cycle".
- COMPRESSOR**, **FAN**, **EVAPORATOR**, **DEFROST**, and **WINDOW** status lamps: The COMPRESSOR and FAN lamps are currently lit green, while the others are grey. A callout for the EVAPORATOR lamp says: "Status lamps indicating whether the specified equipment is active (green) or inactive (grey)".
- Function Keys (F1-F8)**: Located at the bottom of the screen.

A vertical 'TOUCH' label is visible on the right side of the screen.

Note: During normal operation the fan and compressor will switch on/off as required according to the chamber temperature. During defrost, the compressor and fan are switched off and the evaporator heaters are energised for the duration of the defrost cycle. When the defrost period is complete, the system will revert back.

Operating Instructions Cont.

3.11 ACCESS INTO TO THE CHAMBER

The Cryochamber unit has two lids. A large access lid and a smaller lid within.

3.11.1 LARGE ACCESS LID

The large access lid is mainly used when cleaning or maintaining the microtome.



Caution: Before lifting the large access lid, please ensure the smaller glass lid is closed and locked into position.

3.11.2 SMALL ACCESS LID

The small access lid features a heated glass window to stop the glass from fogging up allowing the user to look into the chamber without any of the lids open.

When using the machine it is recommended to gain access into the chamber via this lid as the smaller opening reduces the air transfer between the cool internal air with the warmer external air helping to maintain a more consistent chamber environment.



Caution: Please ensure lids are positioned in their fully opened positions and are stable before going into the chamber.

Operating Instructions Cont.

3.12 FITTING A KNIFE

- Loosen both Clamping handles and set knife holder to its shallowest angle (10°).
- Remove all parts that go onto the knife holder, leaving it clear to fit a new knife.
- Carefully place knife into the cutout in the holder and firmly secure with the Knife fixing bolts.
- Fit the Knife cover over knife and secure with its fixing bolts.
- If using solid knife you can now fit the Anti-roll assembly (Optional).
- Set the blade to the correct angle (Solid 10° Feather blade 15°-20°) then re-tighten the Clamping handles to secure.

Note: To remove the knife, remove all parts in reverse order that they are assembled in the steps above.

Note: To replace a feather blade, the Feather blade knife holder does not have to be removed as per the step by step instructions on this page. The feather blade is held by the four clamping bolts.

Caution: Care needs to be taken when handling knives as they are heavy and very sharp.

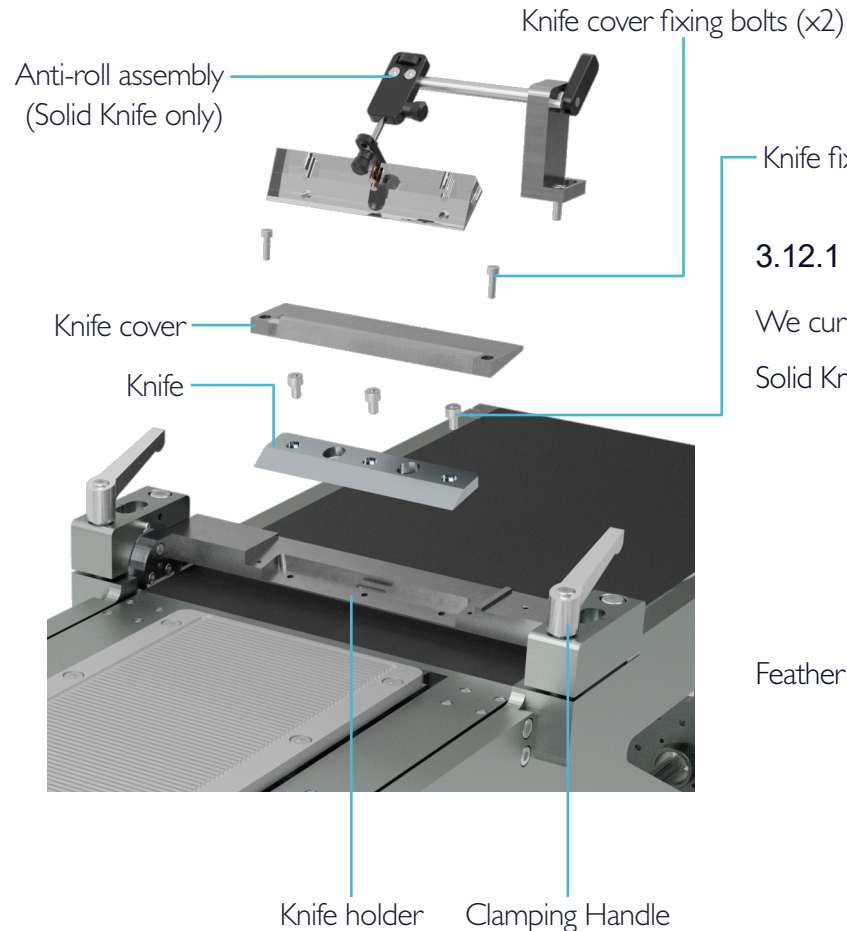

3.12.1 TYPES OF KNIFE

We currently offer the following knife options:

Solid Knife (246-090)

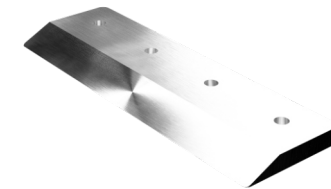

Feather blade knife holder (246-091)

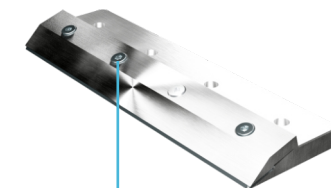

Clamping bolt

Operating Instructions Cont.

3.13 FITTING A SPECIMEN PLATE

- a. If knife is fitted be vigilant of the blade edge.
- b. Using the touch screen in manual mode raise the stage to the highest position.
- c. Wait until the motors inhibited light is illuminated before putting hands near machine.
- d. Check that the underneath of the object holder and the top of the stage are scrupulously clean.
- e. Position the object holder onto the stage holder and bolt down. (Most object holders mount centrally to stage).
- f. Once specimen plate has cooled down the specimen can now be mounted to the plate (This step can be skipped if specimen and stage were already externally prepared).
- g. Again, in manual mode, lower the object holder as so the top of the specimen is just lower than the bottom of the knife edge.
- h. Start trimming the specimen until a suitable starting position is reached.
- i. The removal instructions are very similar to those above for fitting the object holder. Always be aware of the blade edge.

Caution: It is recommended to fit the Specimen plate before the knife is fitted to the microtome. If knife is fitted be vigilant of the blade edge.

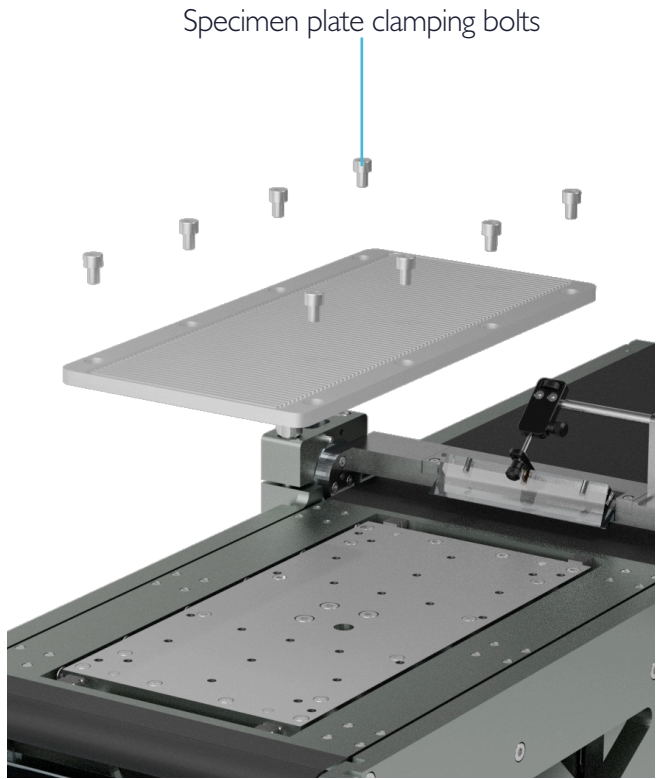

3.13.1 SPECIMEN PLATE OPTIONS

400mm x 150mm (246-436)



300mm x 150mm (246-435)

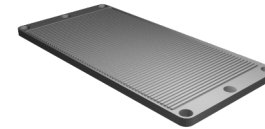

200mm x 150mm (246-434)

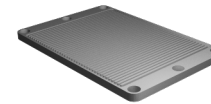

200mm x 150mm (Mounts on front of stage) (246-437)



100mm x 100mm (246-433)

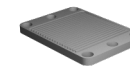

Operating Instructions Cont.

3.14 ANTI ROLL ASSEMBLY

The Anti-Roll plate is a device for ensuring that tissue sections pass down the blade face without curling, so that they can be collected flat.

The setting up of the Anti-Roll plate is second only in importance to the quality of the blade edge in obtaining ribbons of high quality sections.

Step 1: Preparation

- Clamp a frozen specimen (or embedding compound alone) into the microtome.
- Install a sharp microtome knife, setting the appropriate clearance angle for that particular knife.
- Trim the specimen or embedding medium until a suitable block face is made. Go on to step 2.

Step 2: Setting the Anti-Roll Plate

To ensure optimum sectioning performance the Anti-Roll plate must be kept clean from grease and dirt. To clean the anti-roll plate carefully apply a small amount of methylated spirits or ethanol to both the upper and lower surfaces using a clean, dry, soft paper towel.

- Place the Anti-Roll plate against the knife to see where the plate edge is positioned in relation to the blade edge, the edge of the plate should be positioned slightly behind the knife edge, if this not the case, use the adjustment knob to re-position (See Figure 3).

Note: If the edge of the Anti-Roll plate is in-front of the edge of the knife lift it from the knife to adjust, dragging the Anti-Roll plate backwards while on the knife could result in damage to the Anti-Roll plate and knife).

- Lightly tighten the Anti-Roll adjustment lock so that the Anti-Roll adjustment knob can still be turned.
- Place the Anti-Roll plate back against the knife and start to cut sections again. If the plate is too low they will curl up on the tip of the knife.
- Loosen the Anti-Roll adjustment knob and adjust the angle between the bottom face of the plate and

the blade, set the angle somewhere between 10°-15°.

- Slowly turn the anti-roll adjusting knob while cutting sections. When the plate reaches the correct position, the sections will start to slide under the plate.
- Tighten the Anti-roll adjustment lock then flip the plate away from the knife. Now flip the plate back into position. When cutting is resumed, sections should go under the plate as before, i.e. the plate has aligned itself. If not, repeat the setting up process.

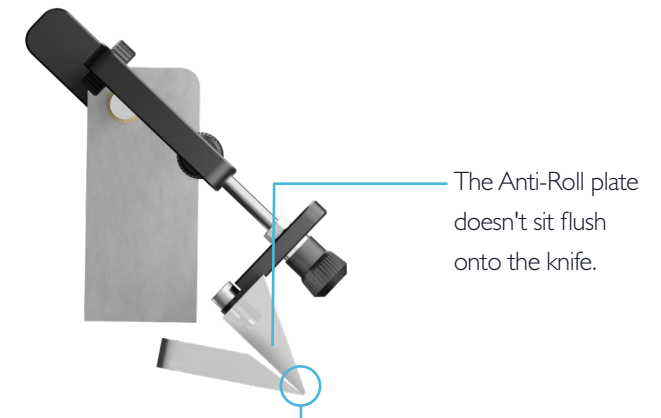

Start with roll plate point below the point of the knife and advance it forward while sectioning until sections slide underneath plate.

Your Anti-Roll plate may vary from the design shown, but the set-up procedure remains the same.

4. Care and Maintenance

4.1 DAILY CARE

Routine daily care consists of removing sectioning debris from the working area and brushing debris & frost from the knife.

4.2 CLEANING UNDER THE DEBRIS BLINDS

The debris blinds fitted to the unit stop the majority of the debris from getting into and under the machine, but occasionally it may be necessary to clean beneath them.

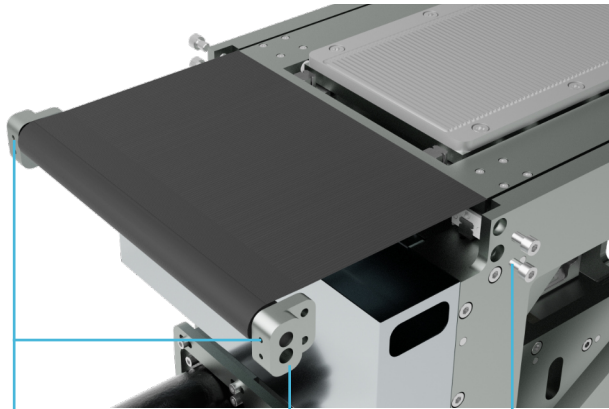

Grub screw locations
(2 per blind)

Debris blind
retaining block
(2 per blind)

Debris blind
retaining block
bolt (4 per blind)

To remove the debris blind follow the steps below:

- a. Power off the unit.
- b. Remove any specimens or Knives from within the unit.
- c. Loosen the two grub screws that stop the blind from spinning.
- d. Remove the four bolts that hold the blind retaining blocks in place (shown in the image), the blind is spring loaded so make sure you have a hold of the blind roll when this is taken off to keep it under control.
- e. The blind can now either be lifted from one end to gain access below or the bolts can be removed from the other end of the blind to completely remove.

4.3 SOLID MICROTOME KNIVES

Great care must be exercised when handling knives:

- Knives must be stored in their boxes when not in use
- Particular care must be taken during cleaning and knife sharpening

Conventional microtome knives are usually made from carbon steel and will corrode in moist conditions.

Whenever the cryostat chamber is allowed to warm up above freezing point (e.g during a full defrost) the knife should be removed, warmed up, cleaned and/or decontaminated, oiled and then stored in its box in a dry place.

The Solid knife normally supplied with the cryostat can be sharpened on a conventional knife sharpening machine. Alternatively, Bright Instrument Co Ltd offer a knife sharpening service.

Care and Maintenance

4.4 DEFROSTING

4.4.1 AUTOMATIC DEFROST CYCLE

To set this please refer to section 3.10.3. The function of the automatic defrost cycle is to clear the evaporator cooling fins of frost. This ensures efficient refrigeration.

Do not exceed the defrost cycle time beyond thirty minutes as this could cause the entire chamber to warm up above 0°C.

4.4.2 FULL DEFROST

It will be necessary to periodically defrost the entire cryostat to carry out cleaning and/or other procedures.

To do this, power off the unit and open up the large chamber lid. Remove any drain plugs at the base of the tank to allow any liquid to drain away. A hairdryer may be used to help speed up this process.

Note: Before turning the refrigeration back on please ensure the microtome is completely dry as any ice build-up in the microtome could negatively affect performance.

4.5 DECONTAMINATION

If decontamination is required carry out the standard procedures as practised in your laboratory. It is the responsibility of the customer to use a decontamination procedure appropriate to his/her work.

The following decontamination method is as recommended in the 'Code of Practice for the Prevention of Infection in Clinical Laboratories and Post-mortem Rooms', ISBN 0 11 320464 7.

- a. Bring the cryostat to room temperature.
- b. Place 50-100ml of formalin BP in a flat dish inside the chamber. Close the window.
- c. Leave for at least 24 hours, preferably 48 hours.
- d. Open the window and place a beaker containing 10ml of ammonia SG.880 in the chamber. Close the window.
- e. Leave for one hour. The cryostat is now decontaminated.

For further information regarding alternative decontamination procedures please refer to 'Safe Working and the Prevention of Infection in Clinical Laboratories', ISBN 0 11 885446 1.

4.6 OPERATING IN HOT CLIMATES

We recommend our machines to be used in climate controlled rooms with a constant temperature within +5°C & +22°C. Un-maintained room temperatures may impact negatively on performance.

Where conditions of high humidity exist, it may be necessary to adjust the automatic defrost cycle or perform extra cycles in order to ensure that the evaporator cooling fins remain frost free.

We advise if its possible to preform the majority of work through the small access lid. It is also recommended to close all lids when machine is not in use, both recommendations aim to reduce the amount of warm external air mixing with the cool air inside the chamber.

4.7 SERVICING AND REPAIRS

In the event of a breakdown a qualified person should be called.

If a service visit is required, the cryostat should be defrosted, decontaminated, cleaned thoroughly and left switched off in preparation for that visit, unless otherwise advised by the engineer. Failure to carry out this action will result in the service visit being cancelled and could incur further call-out charges. A completed decontamination certificate must be left with the cryostat and work will not commence until the engineer has seen a completed certificate.

If the cryostat or any part of it is returned to the distributor or manufacturer, it must be decontaminated and cleaned thoroughly. A completed decontamination certificate must be either sent in advance or attached to the outside of the packaging of the returned goods.

Work on the returned goods will not proceed until the decontamination certificate has been received. Should no decontamination certificate be received, or the cryostat or any part of it be received in a condition that Bright Instrument Co Ltd consider to be a potential biological hazard, the cryostat or part will be returned, un-repaired, at the expense of the customer.

4.7.1 UK

For customers in the UK, Bright Instrument Co Ltd offer a comprehensive range of after sales services that include extended warranties and a full range of service contracts. For further information or for any refrigeration, electrical or mechanical problems contact Bright Instrument Co Ltd direct providing the following information:

- Serial Number (see ID plate on rear panel)
- Nature of fault

4.7.2 REST OF THE WORLD

Refrigeration problems are likely to be rare and will normally be dealt with by a local refrigeration specialist. For electrical and mechanical problems contact your local distributor of Bright products providing the following information:

- Serial Number (see ID plate on rear panel)
- Nature of fault

Accessories

Spares & Accessories

SPECIMEN PLATES

Code	Description
246-433	100mm x 100mm Specimen plate
246-434	200mm x 150mm Specimen plate
246-435	300mm x 150mm Specimen plate
246-436	400mm x 150mm Specimen plate
246-437	200mm x 150mm Front mounting Specimen plate
57937	Spare Specimen plate bolts (Pack of 20)

KNIVES & BLADES

Code	Description
246-090	Hardened steel knife
246-466	Solid knife cover
246-091	Feather blade knife holder
246-469	Feather blade cover
54328	Feather blades (Pack of 10)
57938	Spare Knife fixing bolts (Pack of 10)
57939	Spare Knife cover fixing bolts (Pack of 10)
57940	Spare Feather blade clamping bolts (Pack of 10)

ANTI-ROLL PLATES

Code	Description
54321	120mm Anti-roll plate
54322	150mm Anti-roll plate

ANCILLARY ITEMS

Code	Description
57808	Anti static brush 12mm.
57344	Knife cleaning brush.
53581	Bright Cryo- M-Bed 120ml carton of 6 bottles.
53581-1	Bright Cryo-M-Bed 120ml bottle.
57713	Bright Cryospray 134 300ml aerosol can, carton of 12 cans.
57713-1	Bright Cryospray 134 300ml aerosol can.
57491	Low temperature oil, 200ml bottle.
57491-1	Low temperature oil, 4.54 litre bottle.

References & Drawings

Figure 1. 9400 Cabinet

- 1. Lockable castor
- 2. Refrigeration unit drainage tap
- 3. Large access lid handle
- 4. Small access lid locking pin
- 5. Small access lid handle
- 6. HMI
- 7. Isolator switch
- 8. Knee control lever
- 9. Adjustable levelling foot

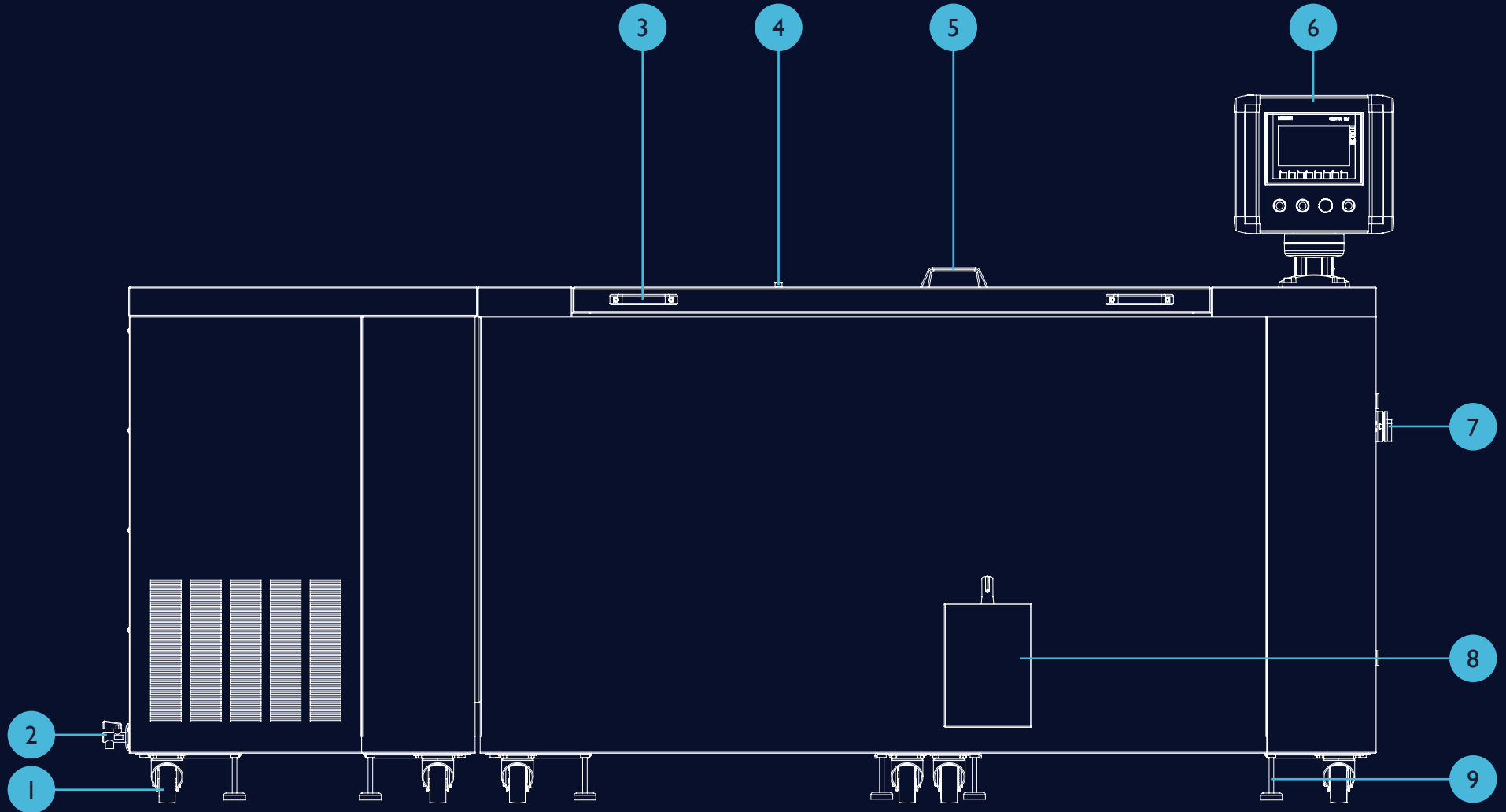

Figure 2. 9400 Microtome

- 1. Debris tray
- 2. Debris blind retaining block
- 3. Debris blind
- 4. Knife holder
- 5. Knife cover
- 6. Anti-Roll assembly
- 7. Knife block
- 8. Specimen holder
- 9. X Axis motor
- 10. Y Axis motor

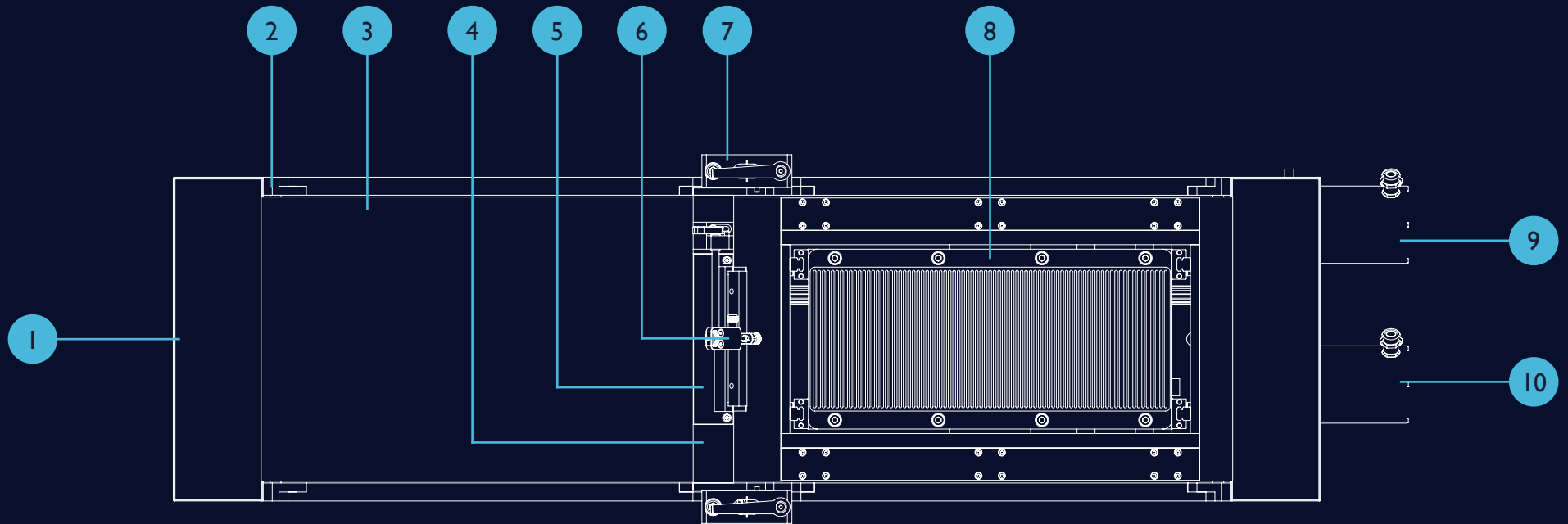
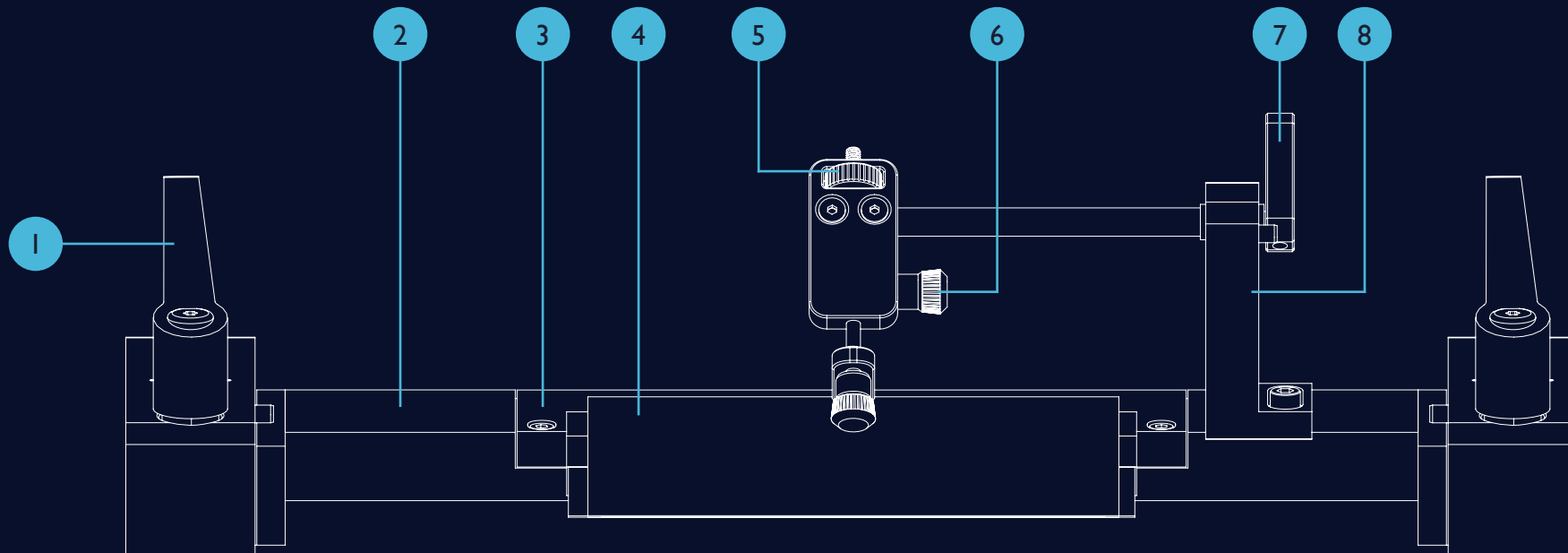

Figure 3. Anti-Roll Set-up

1. Clamping handle
2. Knife holder
3. Knife cover

4. Anti-Roll plate
5. Anti-Roll adjustment knob
6. Anti-Roll adjustment lock

7. Anti-Roll handle
8. Anti-Roll post



HEALTH AND SAFETY AT WORK ACT DECONTAMINATION CERTIFICATE

Customer input

Any product which is to be returned to Bright Instrument Company Limited or serviced on site, must be cleaned and decontaminated in the appropriate manner. This certificate, duly completed, must be either sent in advance (fixed to the outer packing containing the product), or handed to the service engineer.

Packages will not be opened nor servicing commenced until the Company or service engineer have received a satisfactory certificate. Should returned goods be considered a hazard by the Company, they will be returned immediately to the customer at his/her expense.

NB: Microtome knives must be in boxes.

Name: Date:

Signed:

* Such equipment must not be returned without the written agreement of Bright Instrument Company Limited.

Name:	<input type="text"/>	Address:	<input type="text"/>
Position:	<input type="text"/>		
Department:	<input type="text"/>	Postcode:	<input type="text"/>
Company:	<input type="text"/>	Telephone:	<input type="text"/>
Serial No.	<input type="text"/>	Email:	<input type="text"/>
Product No.	<input type="text"/>	Order No.	<input type="text"/>
Description:	<input type="text"/>		
Mark Box A if applicable. Otherwise complete all parts of B, providing further information as requested or appropriate.	A. This equipment has not been in contact with unfixed biological samples.		A:
	B. This equipment has been exposed internally or externally to hazardous materials as indicated below:		B:
Blood, body fluids, pathological samples?	Yes/No:	Other biohazards?	Yes/No:
Chemicals/substances hazardous to health?	Yes/No:	Other hazards?	Yes/No:
Further Details:	<input type="text"/>		
This equipment has been cleaned and decontaminated:			Yes/No:
If Yes, what method?		If No*, why not?	
Further Details:	<input type="text"/>		
The equipment has been prepared to ensure safe handling/transportation.			Yes/No:

Office: Bright Group Holdings Limited, Burnett House, Ermine Business Park, Huntingdon, Cambs, PE29 6UA, UK

Telephone: +44 (0) 808 168 9697
Email: sales@brightinstruments.com

Web: brightinstruments.com
Member: **MADE IN BRITAIN**

Bright
Instruments

Quality Survey Report

Customer input

Our watchword is **QUALITY**. In our continuing endeavour to improve the quality and performance of our processes and products, we would welcome any initial comments on the following aspects of our service and products. As you have only just received the product we do not feel that you could assess the actual workings of the instrument accurately, so we will follow up in approximately six months with a Customer Feedback – Voice of the Customer questionnaire. If, of course, you have any comments to make prior to receiving the questionnaire, please feel free to contact us.

Please return this form for the attention of the QA Manager.

Name:		Address:	
Company:			
Department:		Postcode:	
Serial No.		Telephone:	

PURCHASING: Did the purchasing process run smoothly with respect to our involvement? e.g. correct advice, lead times, payment arrangements etc.	
DELIVERY: Was the instrument in a satisfactory condition on arrival?	
INSTALLATION: Did we install the instrument? If so was adequate pre-use instruction given?	
PURCHASING: Did you receive an operating manual? Do you believe it is comprehensive enough for your use?	
SAFETY: Any comments?	
MISCELLANEOUS: Any other aspect you would like to comment on, e.g. appearance, first impressions etc.	

Date:

Name:

Signed:

Agent / Distributor info:

Bright
Instruments

Bright Instrument Co Ltd,
Burnett House,
Lakeview Court,
Ermine Business Park,
Huntingdon,
Cambridgeshire,
PE29 6UA

United Kingdom

+44 (0) 808 168 9697
brightinstruments.com

Member of:

MADE IN BRITAIN 